

## GNT-2831Ax-Bx (TRIPLE DIGIT LED DISPLAY)

### GNT-2831 Series

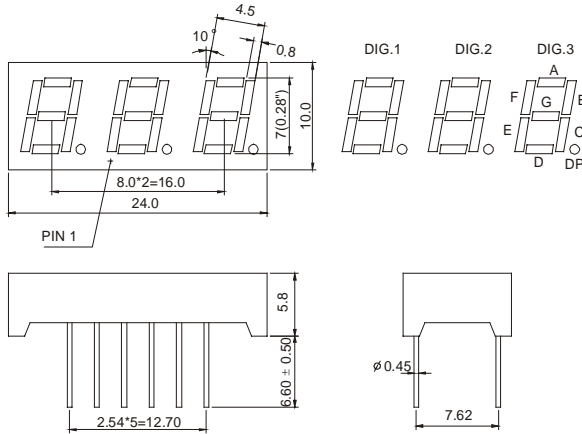

### GNT-2831Ax

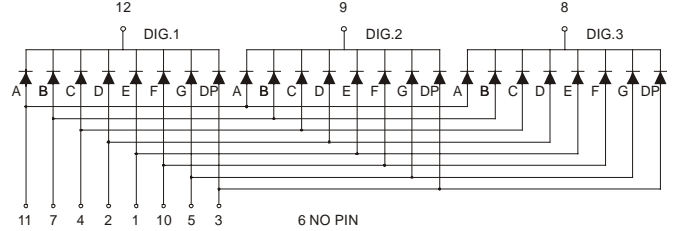

### GNT-2831Bx

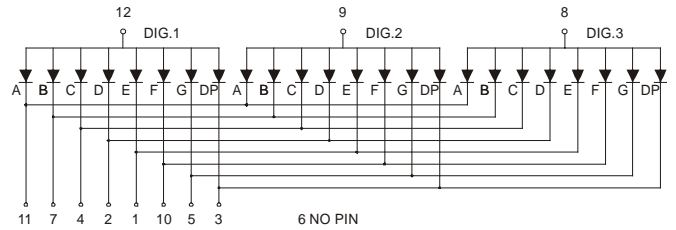

### Features:

\*0.28 INCH HIGH CHARACTER.

\*EXCELLENT CHARACTER APPEARANCE.

\*COMMON CATHODE OR COMMON ANODE.

\*I.C. COMPATIBLE.

\*LOW POWER CONSUMPTION.

Part Number	EMITTED COLOR		Common Cathode or Common Anode	Peak Wavelength (nm)	Vf (v) Typ	If (mA)	Intensity Per Segment (mcd)	
							Min.	Typ.
GNT-2831AE	GaAsP/GaP	Hi.effi Red	Common Cathode	635	2.0	20	9	12
GNT-2831AG	GaP	Green		565	2.1	20	8	11
GNT-2831AY	GaAsP/GaP	Yellow		585	2.0	20	9	12
GNT-2831AS	GaAlAs	Super Red		660	1.8	20	10	13
GNT-2831AD	GaAlAs	Ultra Red		660	1.8	20	25	30
GNT-2831AUE	AlGaInP	Ultra Red		625	2.0	20	30	35
GNT-2831AUY	AlGaInP	Ultra Yellow		590	2.0	20	30	35
GNT-2831BE	GaAsP/GaP	Hi.effi Red	Common Anode	635	2.0	20	9	12
GNT-2831BG	GaP	Green		565	2.1	20	8	11
GNT-2831BY	GaAsP/GaP	Yellow		585	2.0	20	9	12
GNT-2831BS	GaAlAs	Super Red		660	1.8	20	10	13
GNT-2831BD	GaAlAs	Ultra Red		660	1.8	20	25	30
GNT-2831BUE	AlGaInP	Ultra Red		625	2.0	20	30	35
GNT-2831BUY	AlGaInP	Ultra Yellow		590	2.0	20	30	35