

GNS-30011Axx-Bxx (Bi-COLOR DIGIT LED DISPLAY)

GNS-30011 Series

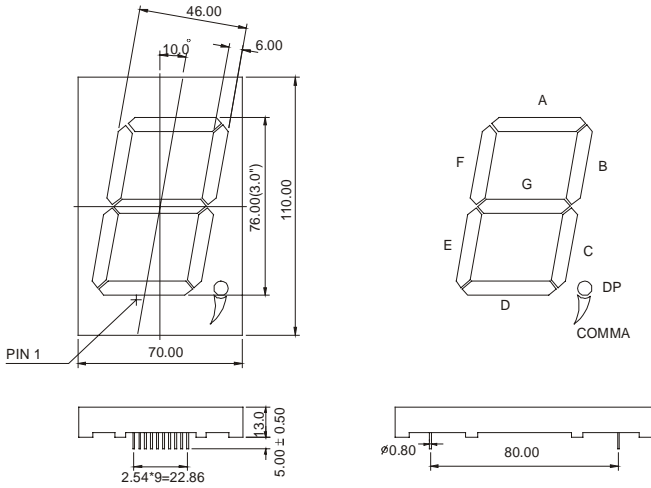

GNS-30011AEG

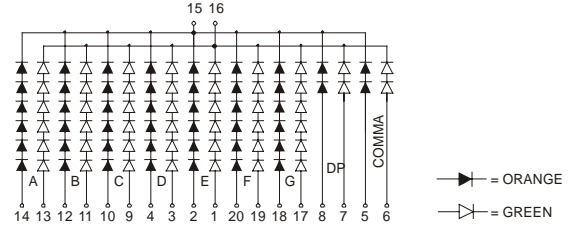

GNS-30011BEG

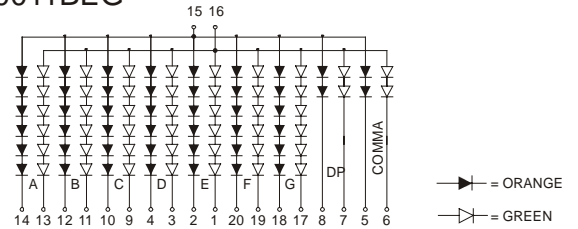

Features:

*3.0 INCH HIGH CHARACTER.

*EXCELLENT CHARACTER APPEARANCE.

*COMMON CATHODE OR COMMON ANODE.

*I.C. COMPATIBLE

*LOW POWER CONSUMPTION.

Part Number	EMITTED COLOR		Common Cathode or Common Anode	Peak Wavelength (nm)	Vf (v) Typ	If (mA)	Intensity Per Segment (mcd)	
							Min.	Typ.
GNS-30011ASG	GaAlAs	Super Red	Common Cathode	660	1.8	20	60	78
	Gap	Green		565	2.1	20	48	66
GNS-30011AEG	GaAsP	Hi.effi Red		635	2.0	20	54	82
	Gap	Green		565	2.1	20	48	66
GNS-30011BSG	GaAlAs	Super Red	Common Anode	660	1.8	20	60	78
	Gap	Green		565	2.1	20	48	66
GNS-30011BEG	GaAsP	Hi.effi Red		635	2.0	20	54	82
	Gap	Green		565	2.1	20	48	66