

GNS-8014Ax-Bx (SINGLE DIGIT LED DISPLAY)

GNS-8014 Series

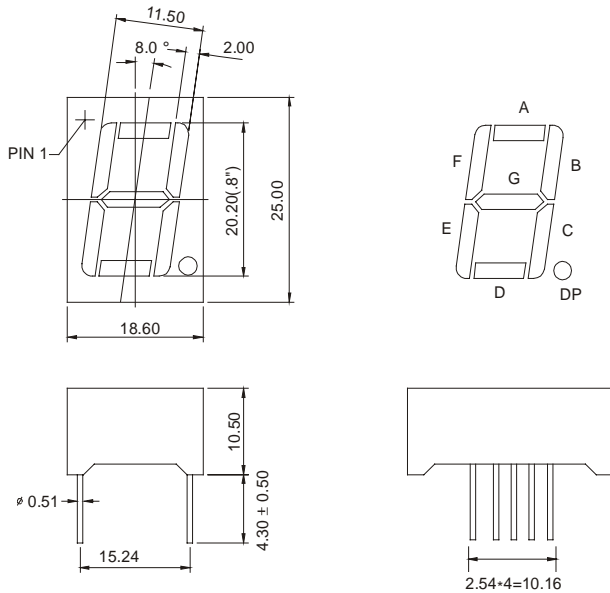

GNS-8014Ax

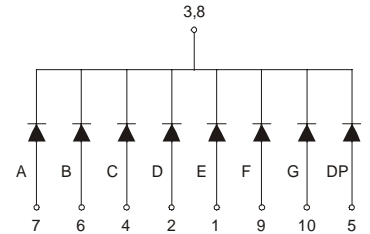

GNS-8014Bx

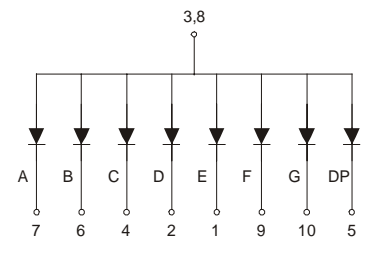

Features:

*0.8 INCH HIGH CHARACTER.

*EXCELLENT CHARACTER APPEARANCE.

*COMMON CATHODE OR COMMON ANODE.

*I.C. COMPATIBLE.

*LOW POWER CONSUMPTION.

Part Number	EMITTED COLOR		Common Cathode or Common Anode	Peak Wavelength (nm)	Vf (v) Typ	If (mA)	Intensity Per Segment (mcd)	
							Min.	Typ.
GNS-8014AE	GaAsP/GaP	Hi.effi Red	Common Cathode	635	2.0	20	9	12
GNS-8014AG	GaP	Green		565	2.1	20	8	11
GNS-8014AY	GaAsP/GaP	Yellow		585	2.0	20	9	12
GNS-8014AS	GaAlAs	Super Red		660	1.8	20	10	13
GNS-8014AD	GaAlAs	Ultra Red		660	1.8	20	25	30
GNS-8014AUE	AlGaInP	Ultra Red		625	2.0	20	30	35
GNS-8014AUY	AlGaInP	Ultra Yellow		590	2.0	20	30	35
GNS-8014BE	GaAsP/GaP	Hi.effi Red	Common Anode	635	2.0	20	9	12
GNS-8014BG	Gap	Green		565	2.1	20	8	11
GNS-8014BY	GaAsP/GaP	Yellow		585	2.0	20	9	12
GNS-8014BS	GaAlAs	Super Red		660	1.8	20	10	13
GNS-8014BD	GaAlAs	Super Red		660	1.8	20	25	30
GNS-8014BUE	AlGaInP	Ultra Red		625	2.0	20	30	35
GNS-8014BUY	AlGaInP	Ultra Yellow		590	2.0	20	30	35