

GNS-4011Cx-Dx (SINGLE DIGIT LED DISPLAY)

GNS-4011 Series

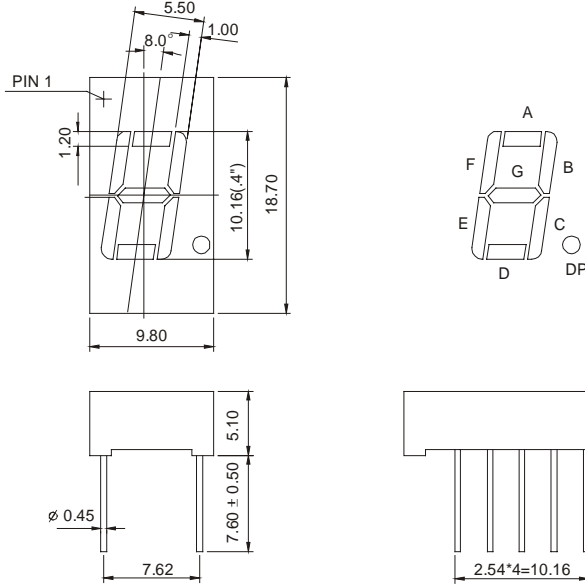

GNS-4011Cx

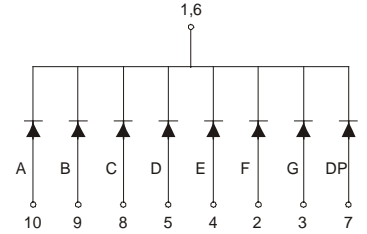

GNS-4011Dx

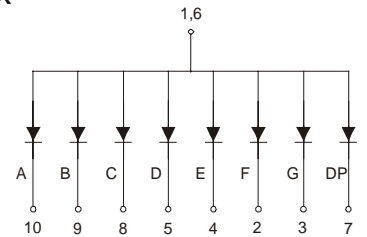

Features:

*0.40 INCH HIGH CHARACTER.

*EXCELLENT CHARACTER APPEARANCE.

*COMMON CATHODE OR COMMON ANODE.

*I.C. COMPATIBLE.

*LOW POWER CONSUMPTION.

Part Number	EMITTED COLOR		Common Cathode or Common Anode	Peak Wavelength (nm)	Vf (v) Typ	If (mA)	Intensity Per Segment (mcd)	
							Min.	Typ.
GNS-4011CE	GaAsP/GaP	Hi.effi Red	Common Cathode	635	2.0	20	9	12
GNS-4011CG	GaP	Green		565	2.1	20	8	11
GNS-4011CY	GaAsP/GaP	Yellow		585	2.1	20	9	12
GNS-4011CS	GaAlAs	Super Red		660	1.8	20	10	13
GNS-4011CD	GaAlAs	Ultra Red		660	1.8	20	25	30
GNS-4011CUE	AlGaInP	Ultra Red		625	1.8	20	30	35
GNS-4011CUY	AlGaInP	Ultra Yellow		590	1.8	20	30	35
GNS-4011DE	GaAsP/GaP	Hi.effi Red	Common Anode	635	2.0	20	9	12
GNS-4011DG	GaP	Green		565	2.1	20	8	11
GNS-4011DY	GaAsP/GaP	Yellow		585	2.1	20	9	12
GNS-4011DS	GaAlAs	Super Red		660	1.8	20	10	13
GNS-4011DD	GaAlAs	Ultra Red		660	1.8	20	25	30
GNS-4011DUE	AlGaInP	Ultra Red		625	1.8	20	30	35
GNS-4011DUY	AlGaInP	Ultra Yellow		590	1.8	20	30	35