

GNS-3011Ex-Fx (SINGLE DIGIT LED DISPLAY)

GNS-3011 Series

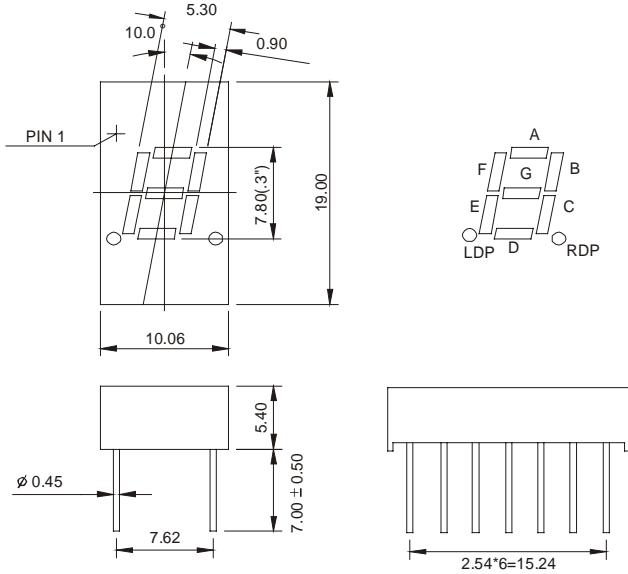

GNS-3011Ex

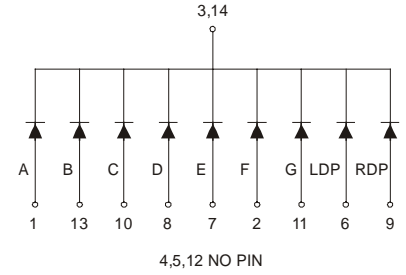

GNS-3011Fx

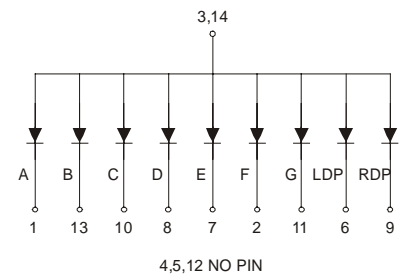

Features:

*0.30 INCH HIGH CHARACTER.

*EXCELLENT CHARACTER APPEARANCE.

*COMMON CATHODE OR COMMON ANODE.

*I.C. COMPATIBLE.

*LOW POWER CONSUMPTION.

Part Number	EMITTED COLOR		Common Cathode or Common Anode	Peak Wavelength (nm)	Vf (v) Typ	If (mA)	Intensity Per Segment (mcd)	
							Min.	Typ.
GNS-3011EE	GaAsP/GaP	Hi.effi Red	Common Cathode	635	2.0	20	9	12
GNS-3011EG	GaP	Green		565	2.1	20	8	11
GNS-3011EY	GaAsP/GaP	Yellow		585	2.0	20	9	12
GNS-3011ES	GaAlAs	Super Red		660	1.8	20	10	13
GNS-3011ED	GaAlAs	Ultra Red		660	1.8	20	25	30
GNS-3011EUE	AlGaInP	Ultra Red		625	2.0	20	30	35
GNS-3011EUY	AlGaInP	Ultra Yellow		590	2.0	20	30	35
GNS-3011FE	GaAsP/GaP	Hi.effi Red	Common Anode	635	2.0	20	9	12
GNS-3011FG	GaP	Green		565	2.1	20	8	11
GNS-3011FY	GaAsP/GaP	Yellow		585	2.0	20	9	12
GNS-3011FS	GaAlAs	Super Red		660	1.8	20	10	13
GNS-3011FD	GaAlAs	Ultra Red		660	1.8	20	25	30
GNS-3011FUE	AlGaInP	Ultra Red		625	2.0	20	30	35
GNS-3011FUY	AlGaInP	Ultra Yellow		590	2.0	20	30	35