

## GNS-3011Cx-Dx (SINGLE DIGIT LED DISPLAY)

### GNS-3011 Series

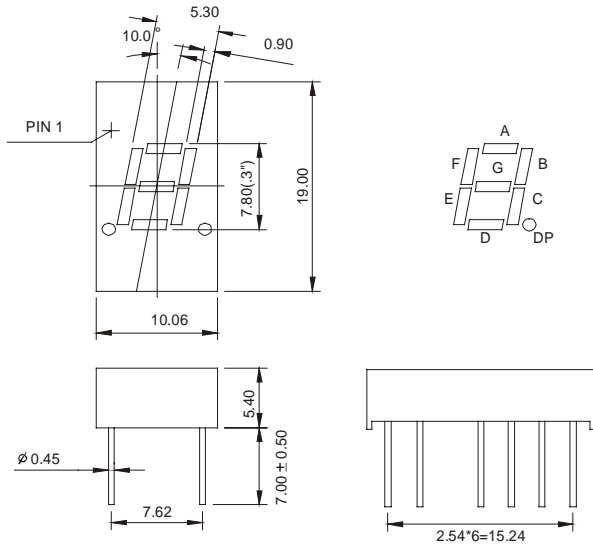

### GNS-3011 Cx

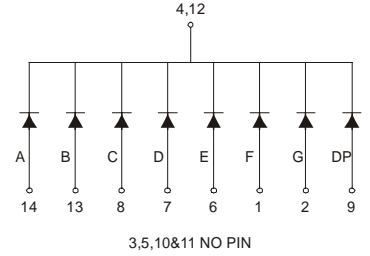

### GNS-3011 Dx

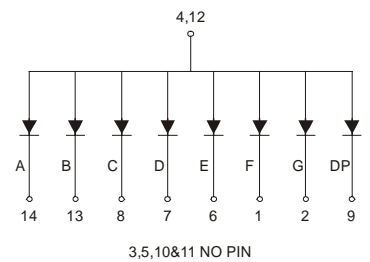

### Features:

\*0.30 INCH HIGH CHARACTER.

\*EXCELLENT CHARACTER APPEARANCE.

\*COMMON CATHODE OR COMMON ANODE.

\*I.C. COMPATIBLE.

\*LOW POWER CONSUMPTION.

Part Number	EMITTED COLOR		Common Cathode or Common Anode	Peak Wavelength (nm)	Vf (v) Typ	If (mA)	Intensity Per Segment (mcd)	
							Min.	Typ.
GNS-3011CE	GaAsP/GaP	Hi.effi Red	Common Cathode	635	2.0	20	9	12
GNS-3011CG	GaP	Green		565	2.1	20	8	11
GNS-3011CY	GaAsP/GaP	Yellow		585	2.0	20	9	12
GNS-3011CS	GaAlAs	Super Red		660	1.8	20	10	13
GNS-3011CD	GaAlAs	Ultra Red		660	1.8	20	25	30
GNS-3011CUE	AlGaInP	Ultra Red		625	2.0	20	30	35
GNS-3011CUY	AlGaInP	Ultra Yellow		590	2.0	20	30	35
GNS-3011DE	GaAsP/GaP	Hi.effi Red	Common Anode	635	2.0	20	9	12
GNS-3011DG	GaP	Green		565	2.1	20	8	11
GNS-3011DY	GaAsP/GaP	Yellow		585	2.0	20	9	12
GNS-3011DS	GaAlAs	Super Red		660	1.8	20	10	13
GNS-3011DD	GaAlAs	Ultra Red		660	1.8	20	25	30
GNS-3011DUE	AlGaInP	Ultra Red		625	2.0	20	30	35
GNS-3011DUY	AlGaInP	Ultra Yellow		590	2.0	20	30	35